

High voltage power Schottky rectifier

Datasheet - production data

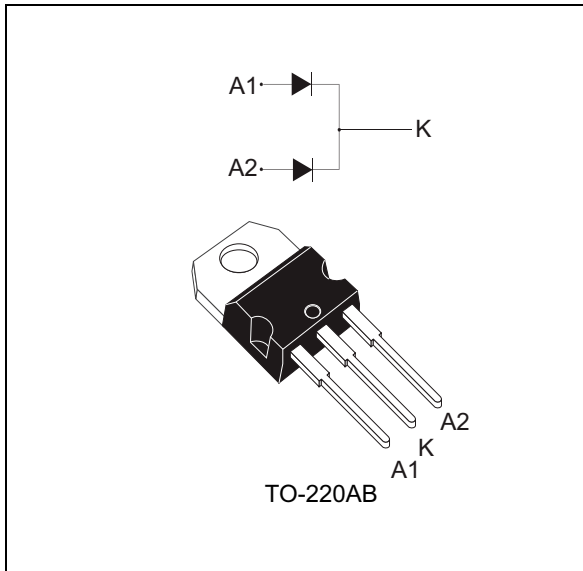

Description

This dual diode Schottky rectifier is suited for high frequency switched mode power supplies.

Packaged in TO-220AB this device is intended for use to enhance the reliability of the application.

Table 1. Device summary

Symbol	Value
$I_{F(AV)}$	2 X 30 A
V_{RRM}	170 V
T_j (max)	175 °C
V_F (max)	0.76 V

Features

- High junction temperature capability
- Good trade-off between leakage current and forward voltage drop
- Low leakage current
- Low thermal resistance
- Avalanche capability specified
- High frequency operation
- ECOPACK[®]2 compliant component

1 Characteristics

Table 2. Absolute ratings (limiting values per diode at $T_{amb} = 25\text{ °C}$ unless otherwise stated)

Symbol	Parameter		Value	Unit
V_{RRM}	Repetitive peak reverse voltage		120	V
$I_{F(RMS)}$	Forward rms current		30	A
$I_{F(AV)}$	Average forward current, $\delta = 0.5$, square wave	$T_c = 150\text{ °C}$	per diode 30	A
			per device 60	
I_{FSM}	Surge non repetitive forward current	$t_p = 10\text{ ms}$ sinusoidal	270	A
P_{ARM}	Repetitive peak avalanche power	$t_p = 10\text{ }\mu\text{s}$, $T_j = 125\text{ °C}$	TBD	W
T_{stg}	Storage temperature range		-65 to + 175	$^{\circ}\text{C}$
T_j	Maximum operating junction temperature ⁽¹⁾		175	$^{\circ}\text{C}$

1. $\frac{dP_{tot}}{dT_j} < \frac{1}{R_{th(j-a)}}$ condition to avoid thermal runaway for a diode on its own heatsink

Table 3. Thermal parameters

Symbol	Parameter		Value	Unit
$R_{th(j-c)}$	Junction to case	per diode	1	$^{\circ}\text{C/W}$
		total	0.7	
$R_{th(c)}$	Coupling		0.4	

When the two diodes 1 and 2 are used simultaneously:

$$\Delta T_j(\text{diode1}) = P(\text{diode1}) \times R_{th(j-c)}(\text{per diode}) + P(\text{diode2}) \times R_{th(c)}$$

Table 4. Static electrical characteristics (per diode)

Symbol	Parameter	Test conditions		Min.	Typ	Max.	Unit
$I_R^{(1)}$	Reverse leakage current	$T_j = 25\text{ °C}$	$V_R = V_{RRM}$	-		35	μA
		$T_j = 125\text{ °C}$		-	8	35	mA
$V_F^{(2)}$	Forward voltage drop	$T_j = 25\text{ °C}$	$I_F = 30\text{ A}$	-		0.94	V
		$T_j = 125\text{ °C}$		-	0.72	0.76	
		$T_j = 25\text{ °C}$	$I_F = 60\text{ A}$	-	0.97	1.05	
		$T_j = 125\text{ °C}$		-	0.86	0.92	

1. Pulse test: $t_p = 5\text{ ms}$, $\delta < 2\%$

2. Pulse test: $t_p = 380\text{ }\mu\text{s}$, $\delta < 2\%$

To evaluate the conduction losses use the following equation:

$$P = 0.60 \times I_{F(AV)} + 0.0053 \times I_{F(RMS)}^2$$

Figure 1. Average forward power dissipation versus average forward current (per diode)

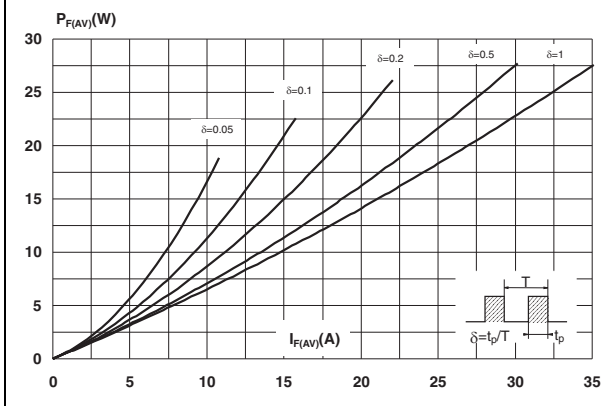

Figure 2. Average forward current versus ambient temperature ($\delta = 0.5$, per diode)

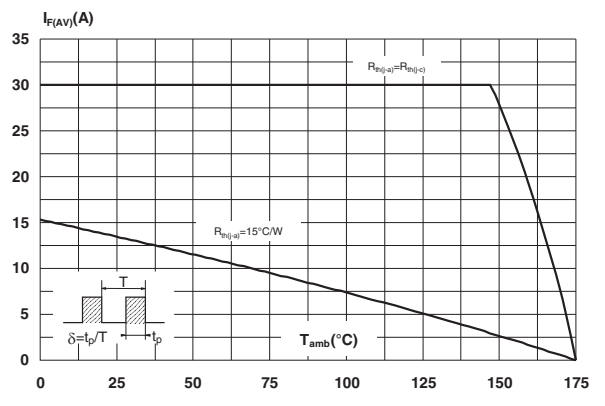

Figure 3. Normalized avalanche power derating versus pulse duration

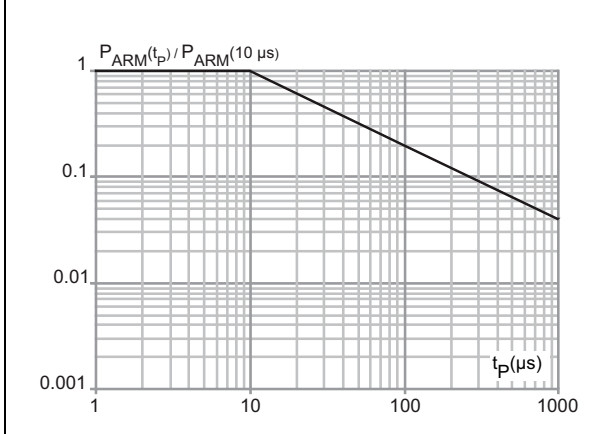

Figure 4. Relative variation of thermal impedance junction to case versus pulse duration

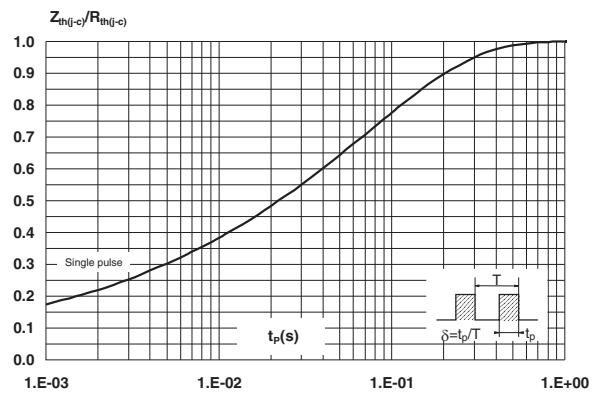

Figure 5. Reverse leakage current versus reverse voltage applied (typical values, per diode)

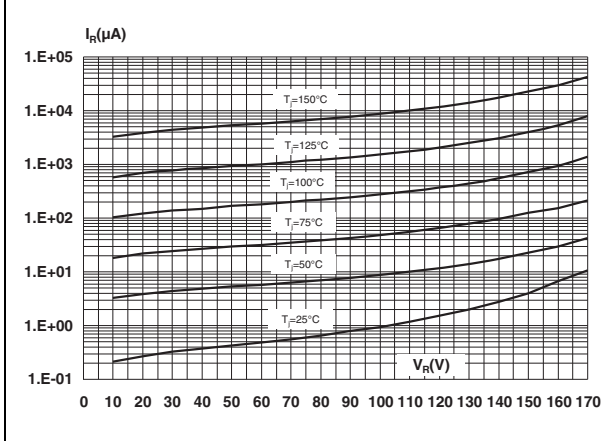

Figure 6. Junction capacitance vs. reverse voltage applied (typical values, per diode)

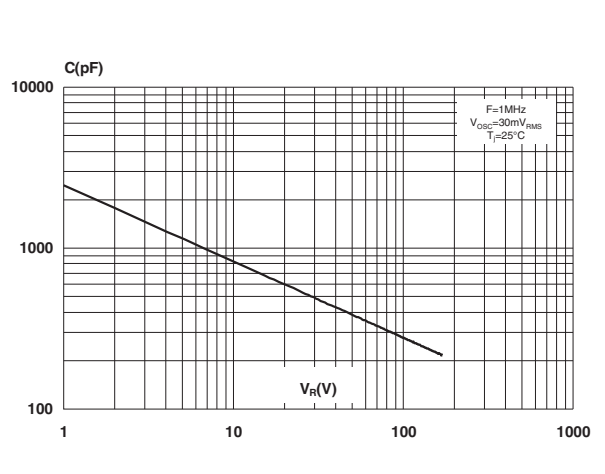

Figure 7. Forward voltage drop versus forward current (per diode, low level)

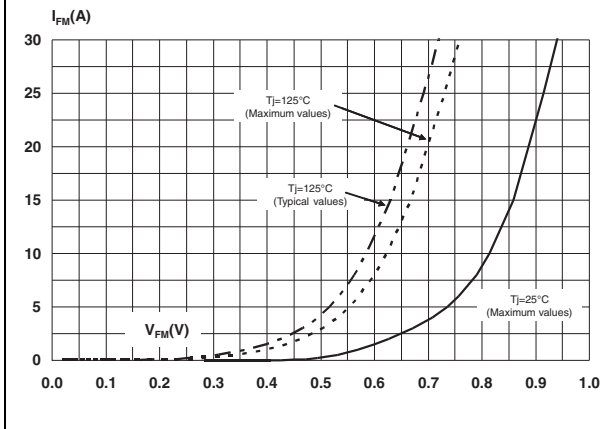
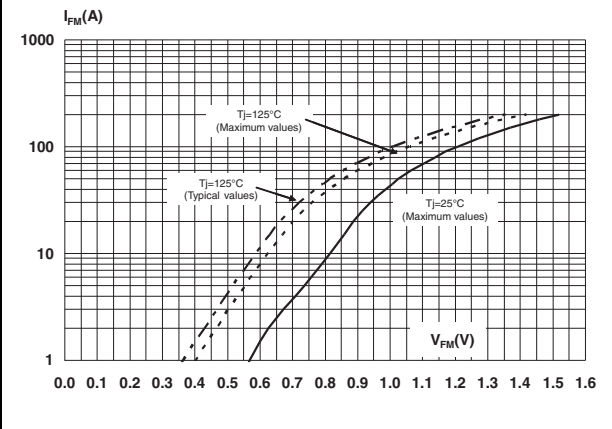

Figure 8. Forward voltage drop versus forward current (per diode, high level)



2 Package information

- Epoxy meets UL94, V0
- Cooling method: by conduction (C)
- Recommended torque value: 0.55 N·m
- Maximum torque value: 0.7 N·m

In order to meet environmental requirements, ST offers these devices in different grades of ECOPACK® packages, depending on their level of environmental compliance. ECOPACK® specifications, grade definitions and product status are available at: www.st.com. ECOPACK® is an ST trademark.

2.1 TO-220AB package information

Figure 9. TO-220AB package outline

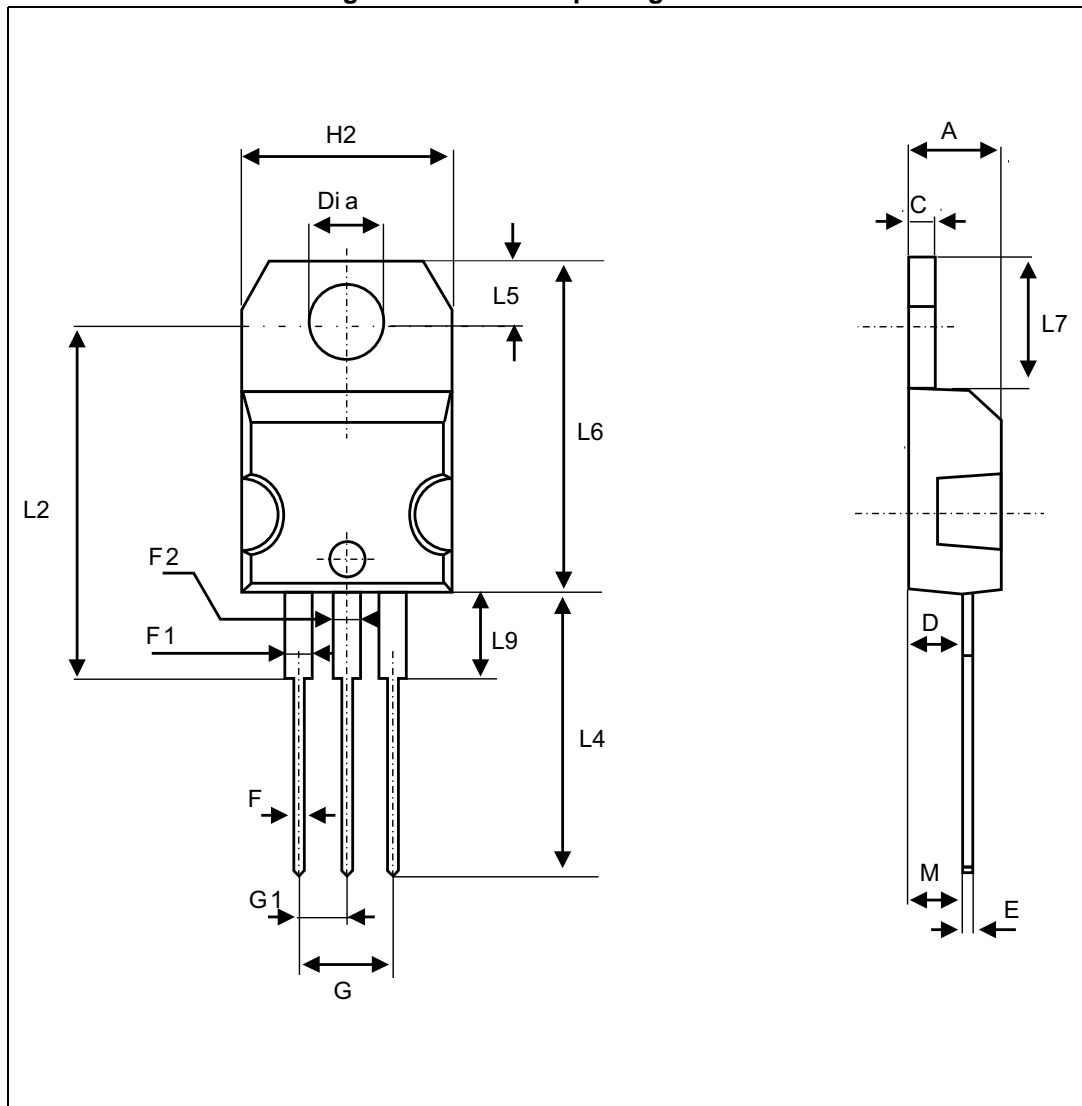

Table 5. TO-220AB package mechanical data

Ref.	Dimensions					
	Millimeters			Inches		
	Min.	Typ.	Max.	Min.	Typ.	Max.
A	4.40		4.60	0.173		0.181
C	1.23		1.32	0.048		0.051
D	2.40		2.72	0.094		0.107
E	0.49		0.70	0.019		0.027
F	0.61		0.88	0.024		0.034
F1	1.14		1.70	0.044		0.066
F2	1.14		1.70	0.044		0.066
G	4.95		5.15	0.194		0.202
G1	2.40		2.70	0.094		0.106
H2	10		10.40	0.393		0.409
L2		16.4 typ.			0.645 typ.	
L4	13		14	0.511		0.551
L5	2.65		2.95	0.104		0.116
L6	15.25		15.75	0.600		0.620
L7	6.20		6.60	0.244		0.259
L9	3.50		3.93	0.137		0.154
M		2.6 typ.			0.102 typ.	
Diam.	3.75		3.85	0.147		0.151

3 Ordering information

Table 6. Ordering information

Ordering type	Marking	Package	Weight	Base qty	Delivery mode
STPS60170CT	STPS60170CT	TO-220AB	2.2 g	50	Tube

4 Revision history

Table 7. Document revision history

Date	Revision	Changes
18-Feb-2005	1	First issue
11-Dec-2015	2	Updated conduction losses equation values and reformatted to current standard.

IMPORTANT NOTICE – PLEASE READ CAREFULLY

STMicroelectronics NV and its subsidiaries ("ST") reserve the right to make changes, corrections, enhancements, modifications, and improvements to ST products and/or to this document at any time without notice. Purchasers should obtain the latest relevant information on ST products before placing orders. ST products are sold pursuant to ST's terms and conditions of sale in place at the time of order acknowledgement.

Purchasers are solely responsible for the choice, selection, and use of ST products and ST assumes no liability for application assistance or the design of Purchasers' products.

No license, express or implied, to any intellectual property right is granted by ST herein.

Resale of ST products with provisions different from the information set forth herein shall void any warranty granted by ST for such product.

ST and the ST logo are trademarks of ST. All other product or service names are the property of their respective owners.

Information in this document supersedes and replaces information previously supplied in any prior versions of this document.

© 2015 STMicroelectronics – All rights reserved