

Honeywell

Honeywell Sensing and

Productivity Solutions

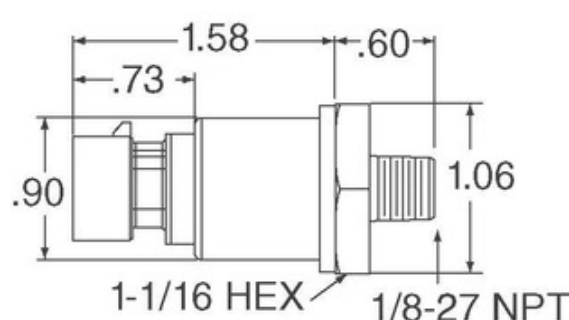

MLH01KPSB06E

Hlutanúmer:

MLH01KPSB06E

Framleiðandi / Vörumerki:

Honeywell Sensing and Productivity Solutions

Vörulýsing

MLH ALL METAL PRESS SENSE -ATF

Gagnablað:

[1.MLH01KPSB06E.pdf](#)
[2.MLH01KPSB06E.pdf](#)

RoHS Staða

 Leiða frjálts / RoHS samhæft

Skip frá

Hong Kong

Sending vegur

DHL/Fedex/TNT/UPS/EMS

BEIÐNI UM TILVITNUN

Mynd getur verið fulltrúi. Sjá upplýsingar um upplýsingar um vörur.







Upplýsingar um MLH01KPSB06E

HLUTANÚMER	MLH01KPSB06E
FRAMLEIÐANDI	Honeywell Sensing and Productivity Solutions
LÝSING	MLH ALL METAL PRESS SENSE -ATF
LEIÐA FRJÁLTS STAÐA / ROHS STAÐA	Leiða frjálts / RoHS samhæft
GÖGN	1.MLH01KPSB06E.pdf 2.MLH01KPSB06E.pdf
SPENNA - FRAMBOÐ	7 V ~ 30 V
BIRGIR TÆKI PAKKI	-
RÖÐ	MLH
ÞRÝSTINGUR TEGUND	Sealed Gauge
PORT STYLE	Threaded
HAFNASTÆRÐ	Male - 1/8" (3.18mm) NPT
PAKKI / TILFELLI	Cylinder, Metal
OUTPUT TEGUND	Analog Voltage
OUTPUT	0.5 V ~ 4.5 V
VINNUHITASTIG	-40°C ~ 125°C
STÝRIÞRÝSTINGUR	1000 PSI (6894.76 kPa)
VÖKTUNARNÆMISSTIG (MSL)	1 (Unlimited)
HÁMARKSPRÝSTINGUR	2000 PSI (13789.51 kPa)
FRAMLEIÐANDI STAÐALL LEIÐSLUTÍMI	10 Weeks
LEIÐA FRJÁLTS STAÐA / ROHS STAÐA	Lead free / RoHS Compliant
LÖGUN	Amplified Output, Temperature Compensated
NÁKVÆM LÝSING	Pressure Sensor 1000 PSI (6894.76 kPa) Sealed Gauge Male - 1/8" (3.18mm) NPT 0.5 V ~ 4.5 V Cylinder, Metal
NÁKVÆMNI	±0.25%

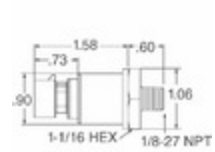
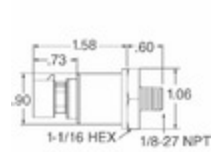
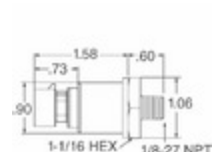
Svipaðir merkingar

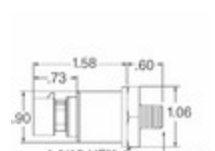
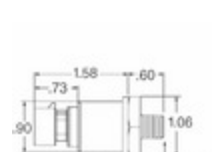
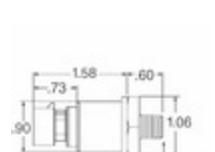
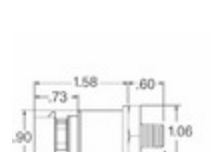
Honeywell Sensing and Productivity Solutions MLH01KPSB06E	MLH01KPSB06E dreifingaraðili	MLH01KPSB06E birgir
MLH01KPSB06E verð	MLH01KPSB06E Myndir	MLH01KPSB06E mynd
MLH01KPSB06E PDF gagnablað	MLH01KPSB06E niðurhal gagnablað	MLH01KPSB06E gagnablað
MLH01KPSB06E lager	Kauptu MLH01KPSB06E	Kauptu Honeywell Sensing and Productivity Solutions MLH01KPSB06E
Honeywell Sensing and Productivity Solutions MLH01KPSB06E	Honeywell Sensing and Productivity Solutions birgir	Honeywell Sensing and Productivity Solutions dreifingaraðili
Honeywell Sensing and Productivity Solutions MLH01KPSB06E	HONEYWELL MLH01KPSB06E	Honeywell Sensing and Control EMEA MLH01KPSB06E
Honeywell Sensing and Productivity Solutions T&M MLH01KPSB06E		

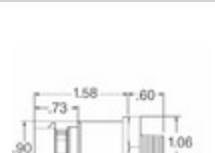
skyldar vörur

 <p>MLH01KPSM06A Framleiðendur: Honeywell Sensing and Productivity Solutions Lýsing: SENSOR SEALED GAUGE 0-1000 PSI Á lager: Out stock</p> <p>RFQ</p>	 <p>MLH01KPGB06C Framleiðendur: Honeywell Sensing and Productivity Solutions Lýsing: MLH ALL METAL PRESS SENSE -ATF Á lager: Out stock</p> <p>RFQ</p>
 <p>MLH01KPSB06A Framleiðendur: Honeywell Sensing and Productivity Solutions Lýsing: SENSOR AMP 1000PSI .5-4.5VDC OUT Á lager: 21 pcs</p> <p>RFQ</p>	 <p>MLH01KPSB01A Framleiðendur: Honeywell Sensing and Productivity Solutions Lýsing: SENSOR AMP 1000PSI .5-4.5VDC Á lager: 78 pcs</p> <p>RFQ</p>
 <p>MLH01KPSB06A Framleiðendur: Honeywell Sensing and Productivity Solutions Lýsing: SENSOR AMP 1000PSI .5-4.5VDC OUT Á lager: 21 pcs</p> <p>RFQ</p>	 <p>MLH01KPSB21A Framleiðendur: Honeywell Sensing and Productivity Solutions Lýsing: MLH ALL METAL PRESS SENSE -ATF Á lager: Out stock</p> <p>RFQ</p>
 <p>MLH01KPSD01A Framleiðendur: Honeywell Sensing and Productivity Solutions Lýsing: MLH ALL METAL PRESS SENSE -ATF Á lager: Out stock</p> <p>RFQ</p>	 <p>MLH01KPSB06G Framleiðendur: Honeywell Sensing and Productivity Solutions Lýsing: MLH ALL METAL PRESS SENSE -ATF Á lager: Out stock</p> <p>RFQ</p>
 <p>MLH01KPSL01A Framleiðendur: Honeywell Sensing and Productivity Solutions Lýsing: SENSOR SEALED GAUGE 0-1000 PSI Á lager: Out stock</p> <p>RFQ</p>	 <p>MLH01KPSB01B Framleiðendur: Honeywell Sensing and Productivity Solutions Lýsing: SENSOR AMP 1000PSI 4-20MA OUT Á lager: 40 pcs</p> <p>RFQ</p>
 <p>MLH01KPSB06A Framleiðendur: Honeywell Sensing and Productivity Solutions Lýsing: MLH ALL METAL PRESS SENSE -ATF Á lager: Out stock</p> <p>RFQ</p>	 <p>MLH01KPSB06B Framleiðendur: Honeywell Sensing and Productivity Solutions Lýsing: SENSOR AMP 1000PSI 4-20MA OUT Á lager: 6 pcs</p> <p>RFQ</p>