

Panasonic

Panasonic

ARXP1003

Hlutanúmer:

ARXP1003

Framleiðandi / Vörumerki:

Panasonic

Vörulýsing

RELAY RF SPDT 500MA 3V

Gagnablað:

 ARXP1003.pdf

RoHS Staða

 Leiða frjáls / RoHS samhæft

Skip frá

Hong Kong

Sending vegur

DHL/Fedex/TNT/UPS/EMS

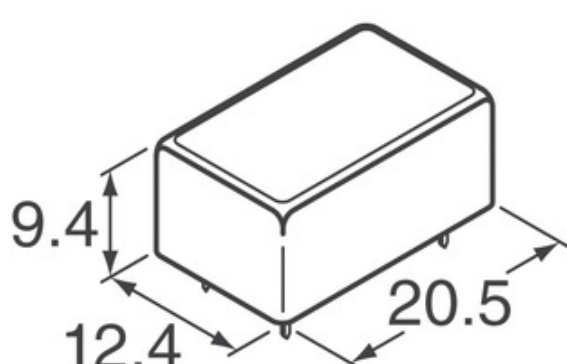

Mynd getur verið fulltrúi. Sjá upplýsingar um upplýsingar um vörur.













Upplýsingar um ARXP1003

HLUTANÚMÉR	ARXP1003
FRAMLEIÐANDI	Panasonic
LÝSING	RELAY RF SPDT 500MA 3V
LEIÐA FRJÁLS STAÐA / ROHS STAÐA	Leiða frjáls / RoHS samhæft
GÖGN	 ARXP1003.pdf
KVEIKJA Á SPENNA (HÁMARK)	2.25 VDC
SLÖKKVA Á SPENNU (MIN)	0.3 VDC
UPPSAGNARSTÍLL	PC Pin
SKIPTA SPENNU	30VDC - Max
RÖÐ	ARXP
SLEPPTU TÍMA	6ms
PÖKKUN	Tube
ÖNNUR NÖFN	255-2718
VINNUHITASTIG	-40°C ~ 70°C
STARFAÐU TÍMA	10ms
UPPSETNINGARTEGUND	Through Hole
VÖKTUNARNÆMISSTIG (MSL)	1 (Unlimited)
LEIÐA FRJÁLS STAÐA / ROHS STAÐA	Lead free / RoHS Compliant
LÖGUN	-
TENGILIÐUR EINKUNN (NÚVERANDI)	500mA
SNERTINGAREFNI	Gold Plating
TENGILIÐUR	SPDT (1 Form C)
SPÓLU SPENNA	3VDC
SPÓLU TEGUND	Non Latching
SPÓLUPÓL	45 Ohms
SPÓLUORKA	200 mW
SPÓLU NÚVERANDI	66.7mA

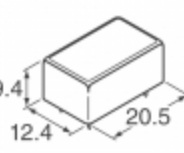
Svipaðir merkingar

Panasonic ARXP1003	ARXP1003 dreifingaraðili	ARXP1003 birgir
ARXP1003 verð	ARXP1003 Myndir	ARXP1003 mynd
ARXP1003 PDF gagnablað	ARXP1003 niðurhal gagnablað	ARXP1003 gagnablað
ARXP1003 lager	Kauptu ARXP1003	Kauptu Panasonic ARXP1003
Panasonic ARXP1003	Panasonic birgir	Panasonic dreifingaraðili
Panasonic ARXP1003	Panasonic - Consumer Division ARXP1003	Panasonic - Consumer Electronics Corp. ARXP1003
Panasonic Battery Group ARXP1003	Panasonic Electric Works - ACSD ARXP1003	Panasonic Electronic Components - Semiconductor Pr ARXP1003
Panasonic - ATG ARXP1003	Panasonic - BSG ARXP1003	Panasonic - DTG ARXP1003
Panasonic Electric Works ARXP1003	Panasonic Electronic Components ARXP1003	Panasonic Industrial Automation Sales ARXP1003
Panasonic Semiconductor ARXP1003		

skyldar vörur

 <p>ARX550AT2C00XPEAH-S216-GEVB Framleiðendur: AMI Semiconductor / ON Semiconductor Lýsing: BOARD EVAL VGA 1/5" CIS HB Á lager: Out stock</p> <p>RFQ</p>	 <p>ARX550AT2R00XPEAH-GEVB Framleiðendur: AMI Semiconductor / ON Semiconductor Lýsing: BOARD EVAL WVGA 1/4" CIS HB Á lager: Out stock</p> <p>RFQ</p>
 <p>ARXP1024 Framleiðendur: Panasonic Lýsing: RELAY RF SPDT 500MA 24V Á lager: Out stock</p> <p>RFQ</p>	 <p>ARX550HDSC00XPEAH-GEVB Framleiðendur: AMI Semiconductor / ON Semiconductor Lýsing: BOARD EVAL VGA 1/5" CIS HB Á lager: Out stock</p> <p>RFQ</p>
 <p>ARXP1009 Framleiðendur: Panasonic Lýsing: RELAY RF SPDT 500MA 9V Á lager: Out stock</p> <p>RFQ</p>	 <p>ARX550AT2C00XPEAH-GEVB Framleiðendur: AMI Semiconductor / ON Semiconductor Lýsing: BOARD EVAL VGA 1/5" CIS HB Á lager: Out stock</p> <p>RFQ</p>
 <p>ARXP1012 Framleiðendur: Panasonic Lýsing: RELAY RF SPDT 500MA 12V Á lager: Out stock</p> <p>RFQ</p>	 <p>ARXP1103 Framleiðendur: Panasonic Lýsing: RELAY RF SPDT 500MA 3V Á lager: Out stock</p> <p>RFQ</p>
 <p>ARX124H Framleiðendur: Panasonic Lýsing: RELAY RF SPDT 500MA 4.5V Á lager: Out stock</p> <p>RFQ</p>	 <p>ARXP104H Framleiðendur: Panasonic Lýsing: RELAY RF SPDT 500MA 4.5V Á lager: Out stock</p> <p>RFQ</p>
 <p>ARXP1006 Framleiðendur: Panasonic Lýsing: RELAY RF SPDT 500MA 6V Á lager: Out stock</p> <p>RFQ</p>	 <p>ARX550HDSC00XPEAH-DRBR1 Framleiðendur: AMI Semiconductor / ON Semiconductor Lýsing: IMAGE SENSOR VGA 1/5" CIS Á lager: Out stock</p> <p>RFQ</p>