



Sensata Technologies, Airpax

66L060-0347

Hlutanúmer:

66L060-0347

Framleiðandi / Vörumerki:

Sensata Technologies, Airpax

Vörulýsing

THERMOSTAT 60 DEG NC 8-DIP

Gagnablað:

 66L060-0347.pdf

RoHS Staða

 Leiða frjáls / RoHS samhæft

Skip frá

Hong Kong

Sending vegur

DHL/Fedex/TNT/UPS/EMS

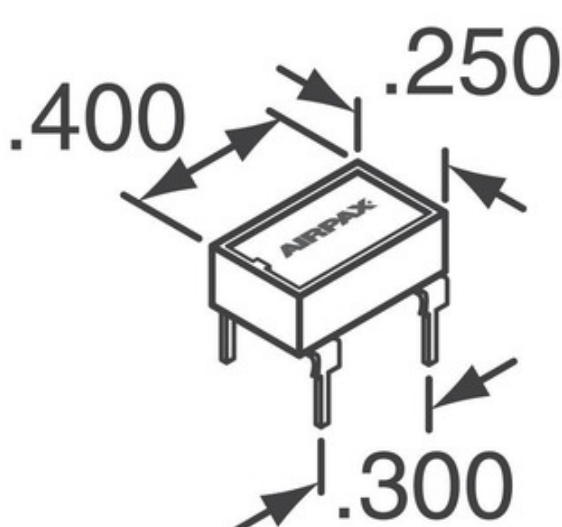

Mynd getur verið fulltrúi. Sjá upplýsingar um upplýsingar um vörur.





Upplýsingar um 66L060-0347

HLUTANÚMÉR	66L060-0347
FRAMLEIÐANDI	Sensata Technologies, Airpax
LÝSING	THERMOSTAT 60 DEG NC 8-DIP
LEIÐA FRJÁLS STAÐA / ROHS STAÐA	Leiða frjáls / RoHS samhæft
GÖGN	 66L060-0347.pdf
TOLERANCE	±9°F (±5°C)
UPPSAGNARSTÍLL	PC Pins
SKIPTA HITASTIG	140°F (60°C)
SKIPTINGARHRINGIR	25K
RÖÐ	6600
ENDURSTILLA HITASTIG	104°F (40°C)
PAKKI / TILFELLI	8-DIP (0.300", 7.62mm), 4 Leads
UPPSETNINGARTEGUND	Through Hole
VÖKTUNARN/EMISSTIG (MSL)	1 (Unlimited)
FRAMLEIÐANDI STAÐALL LEIÐSLUTÍMI	10 Weeks
LEIÐA FRJÁLS STAÐA / ROHS STAÐA	Lead free / RoHS Compliant
NÚVERANDI EINKUNN - DC	1A (48V)
NÚVERANDI EINKUNN - AC	1A (120V)
HRINGRÁS	SPST-NC

Svipaðir merkingar

Sensata Technologies, Airpax 66L060-0347	66L060-0347 dreifingaraðili	66L060-0347 birgir
66L060-0347 verð	66L060-0347 Myndir	66L060-0347 mynd
66L060-0347 PDF gagnablað	66L060-0347 niðurhal gagnablað	66L060-0347 gagnablað
66L060-0347 lager	Kauptu 66L060-0347	Kauptu Sensata Technologies, Airpax 66L060-0347
Sensata Technologies, Airpax 66L060-0347	Sensata Technologies, Airpax birgir	Sensata Technologies, Airpax dreifingaraðili
Sensata Technologies, Airpax 66L060-0347	Sensata Technologies/Airpax 66L060-0347	

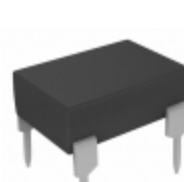
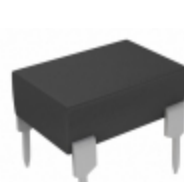
skyldar vörur

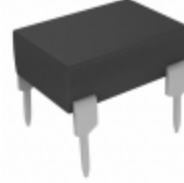
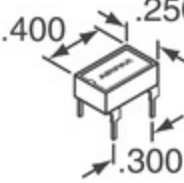
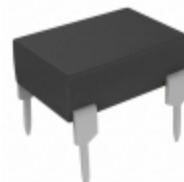
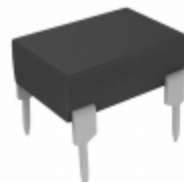
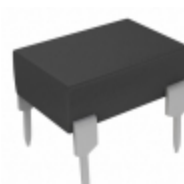
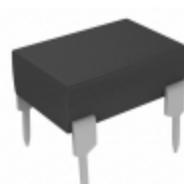
 <p>66L055-0260 Framleiðendur: Sensata Technologies, Airpax Lýsing: THERMOSTAT 55 DEG NC 8SMD Á lager: Out stock RFQ</p>	 <p>66L060-0340 Framleiðendur: Sensata Technologies, Airpax Lýsing: THERMOSTAT 60 DEG NC 8SMD Á lager: 948 pcs RFQ</p>
 <p>66L065 Framleiðendur: Sensata Technologies, Airpax Lýsing: THERMOSTAT 65 DEG NC 8-DIP Á lager: Out stock RFQ</p>	 <p>66L055-0339 Framleiðendur: Sensata Technologies, Airpax Lýsing: THERMOSTAT 55 DEG NC 8-DIP Á lager: Out stock RFQ</p>
 <p>66L060-0530 Framleiðendur: Sensata Technologies, Airpax Lýsing: THERMOSTAT Á lager: Out stock RFQ</p>	 <p>66L065-0256 Framleiðendur: Sensata Technologies, Airpax Lýsing: THERMOSTAT 65 DEG NC 8SMD Á lager: Out stock RFQ</p>
 <p>66L065-0187 Framleiðendur: Sensata Technologies, Airpax Lýsing: THERMOSTAT 65 DEG NC 8-DIP Á lager: Out stock RFQ</p>	 <p>66L060-0367 Framleiðendur: Sensata Technologies, Airpax Lýsing: THERMOSTAT 60 DEG NC 8-DIP Á lager: Out stock RFQ</p>
 <p>66L055 Framleiðendur: Sensata Technologies, Airpax Lýsing: THERMOSTAT 55 DEG NC 8-DIP Á lager: Out stock RFQ</p>	 <p>66L060 Framleiðendur: Sensata Technologies, Airpax Lýsing: THERMOSTAT 60 DEG NC 8-DIP Á lager: 487 pcs RFQ</p>
 <p>66L055-0041 Framleiðendur: Sensata Technologies, Airpax Lýsing: THERMOSTAT 55 DEG NC 8-DIP Á lager: Out stock RFQ</p>	 <p>66L064-0034 Framleiðendur: Sensata Technologies, Airpax Lýsing: THERMOSTAT 64 DEG NC 8-DIP Á lager: Out stock RFQ</p>

Höfundarréttur © 2020 Áreiðanlegur dreifingaraðili rafeindahluta - Ocean-Components.com

Tölvupóstur: Info@Ocean-Components.com

Heimilisfang: Room 2102, Connaught Commercial Building, 185 Wan Chai Rd, Wan Chai, Hong Kong

